

OUTER FRAME

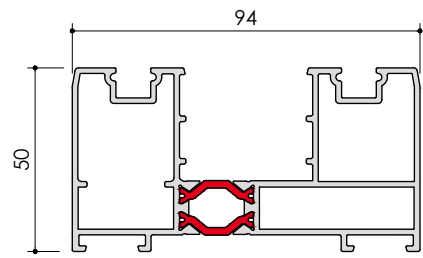

P-15-100

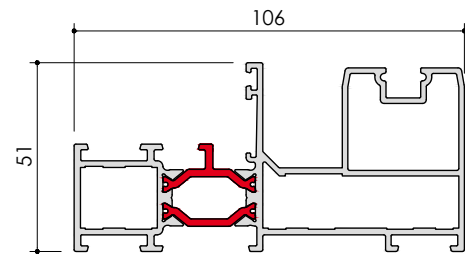

P-15-101

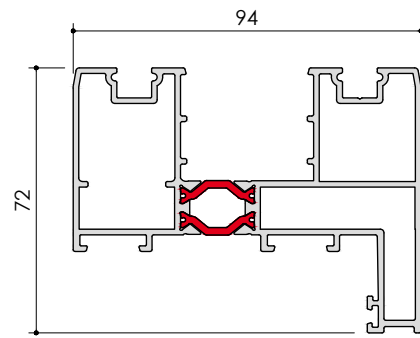

P-15-109

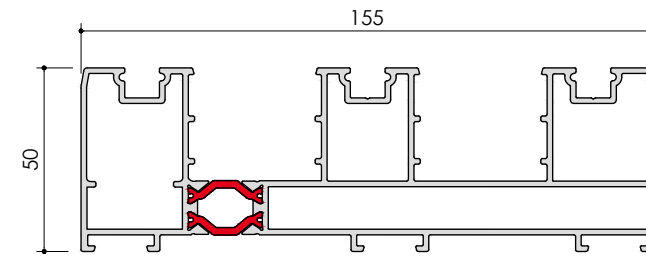

P-15-113

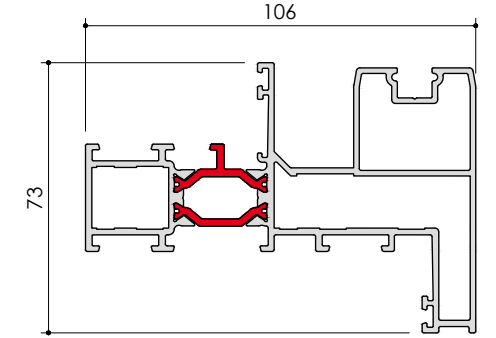

P-15-129

LEAF

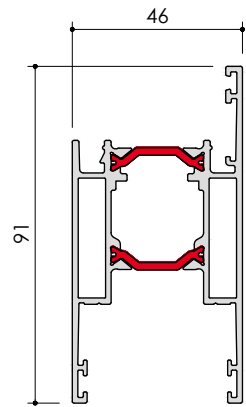

P-15-201

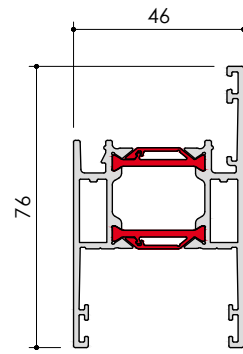

P-15-202

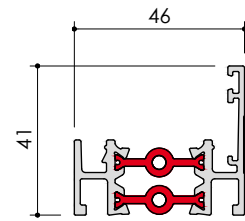

P-15-210

MONORAIL POST

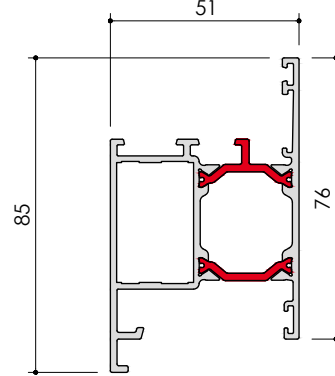

P-15-601

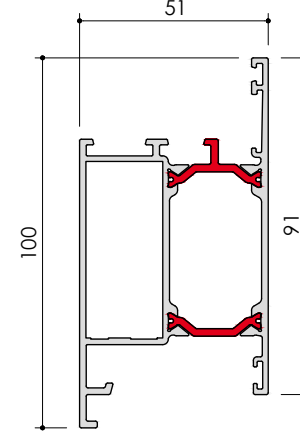

P-15-602

SLIM INTERLOCK

TRACK

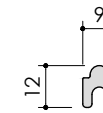

P-05-800

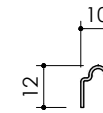

P-05-801

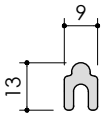

P-25-800

MEETING STILE

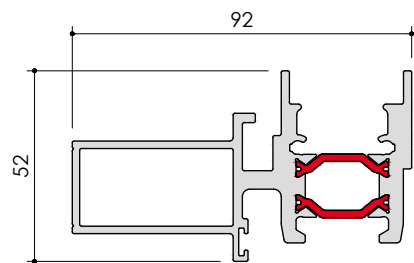

P-15-455

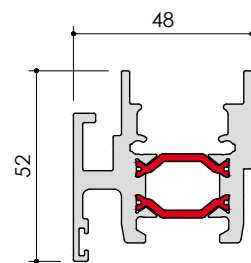

P-15-456

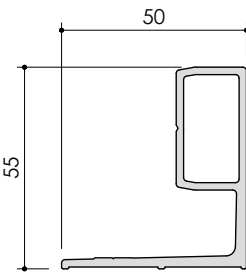

P-15-350

PVC INTERLOCK CHICANE

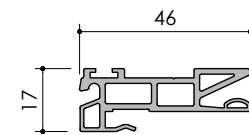

P-15-502

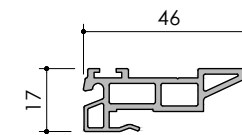

P-15-502b

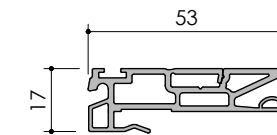

P-15-503

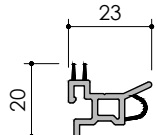

P-15-504

INTERLOCK PLATE

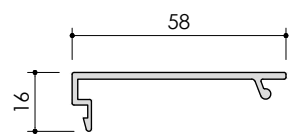

P-15-300

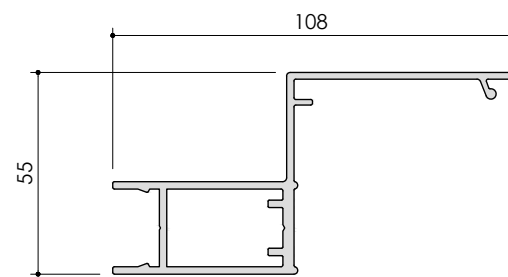

P-15-301

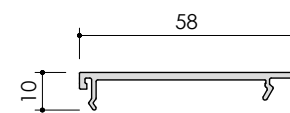

P-15-302

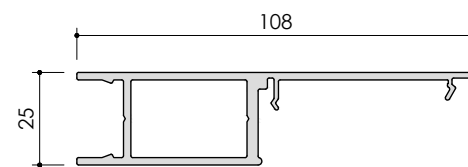

P-15-303

MIDRAIL

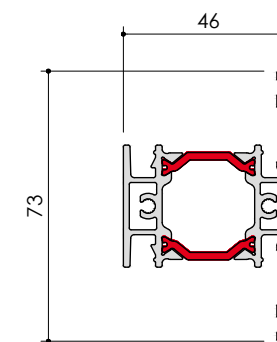

P-15-230

ALUK[®]

www.aluk.co.uk

BSC94

DATE : 03.03.2017

ISSUE : 1

SCALE : 1:1 @ A1

PAGE : 1 of 2

FRAME COVER PLATE

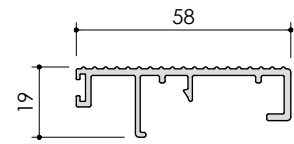

P-15-402

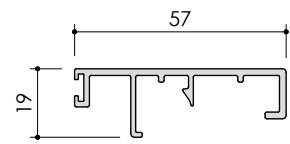

P-15-403

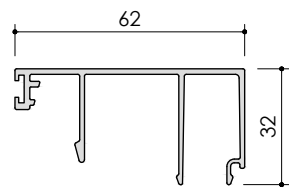

P-00-400r2

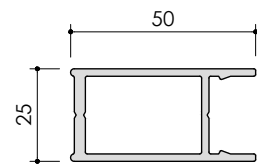

P-00-516

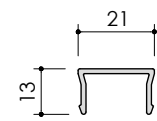

P-00-500

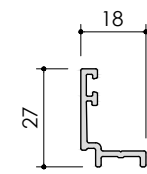

P-00-101

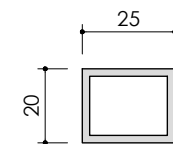

P-00-940

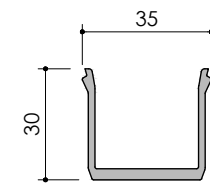

P-05-500

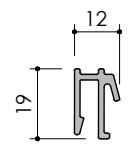

P-05-505

BEAD

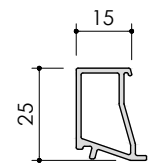

P-6b-015

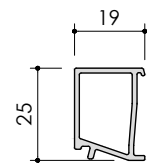

P-6b-019

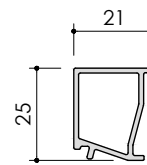

P-6b-021

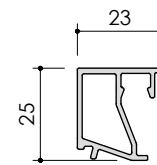

P-6b-023

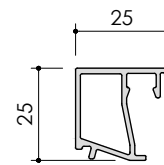

P-6b-025

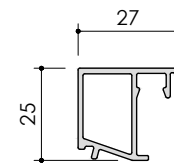

P-6b-027

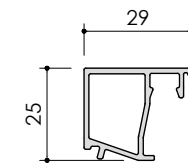

P-6b-029

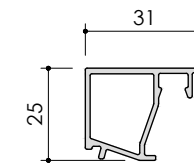

P-6b-031

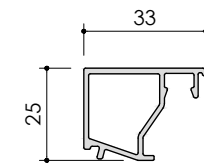

P-6b-033

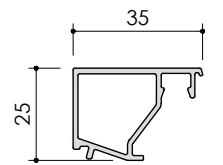

P-6b-035

BEAD

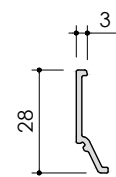

P-6n-003

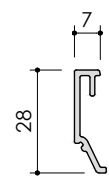

P-6n-007

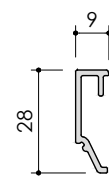

P-6n-009

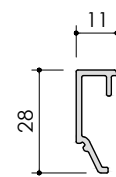

P-6n-011

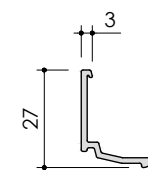

P-6s-003

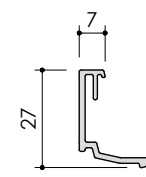

P-6s-007

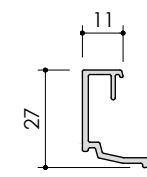

P-6s-011

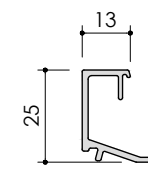

P-6s-013

COUPLING BAR

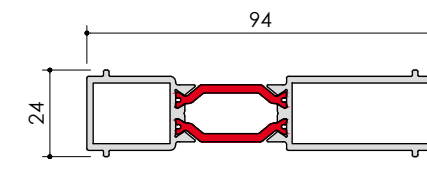

P-15-510

DRIP BAR

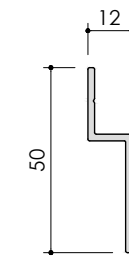

P-00-520

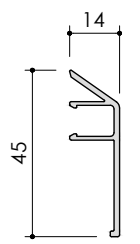

P-00-701

CORNER POST

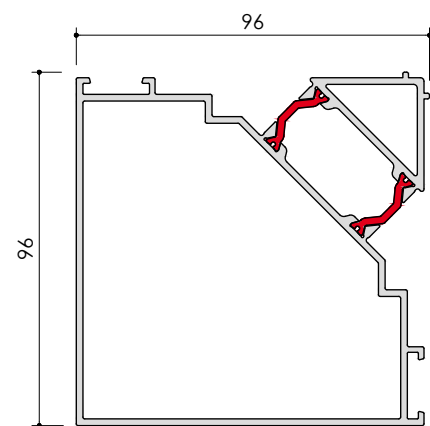

P-15-550

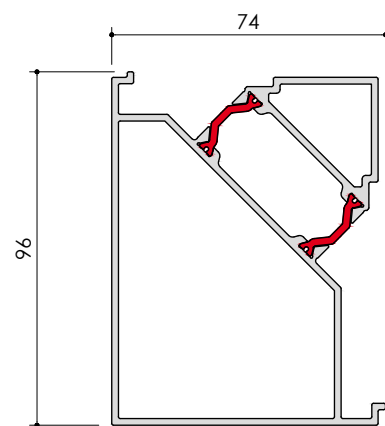

P-15-551

BAY POLE

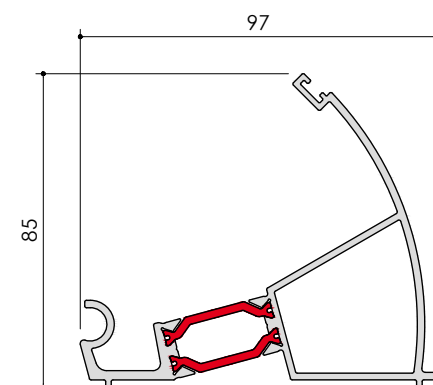

P-15-700

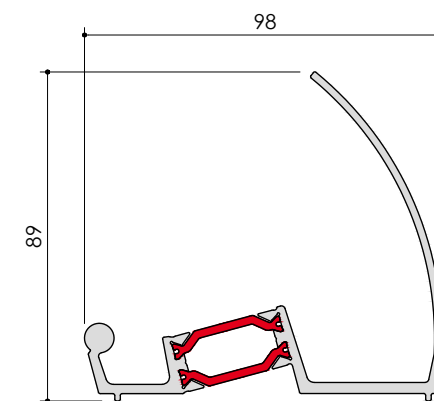

P-15-701

ALUK[®]
 www.aluk.co.uk
BSC94
 DATE : 03.03.2017 ISSUE : 1
 SCALE : 1:1 @ A1 PAGE : 2 of 2